

# DENON

DVD VIDEO PLAYER

# DVD-1740

---

OPERATING INSTRUCTIONS

MODE D'EMPLOI

INSTRUCCIONES DE FUNCIONAMIENTO

**WARNING:** TO REDUCE THE RISK OF FIRE OR ELECTRIC SHOCK, DO NOT EXPOSE THIS APPLIANCE TO RAIN OR MOISTURE.



**CAUTION**  
**RISK OF ELECTRIC SHOCK**  
**DO NOT OPEN**



**CAUTION:**

TO REDUCE THE RISK OF ELECTRIC SHOCK, DO NOT REMOVE COVER (OR BACK). NO USER SERVICEABLE PARTS INSIDE. REFER SERVICING TO QUALIFIED SERVICE PERSONNEL.



The lightning flash with arrowhead symbol, within an equilateral triangle, is intended to alert the user to the presence of uninsulated "dangerous voltage" within the product's enclosure that may be of sufficient magnitude to constitute a risk of electric shock to persons.



The exclamation point within an equilateral triangle is intended to alert the user to the presence of important operating and maintenance (servicing) instructions in the literature accompanying the appliance.

- 1) Read Instructions - All the safety and operating instructions should be read before the product is operated.
- 2) Retain Instructions - The safety and operating instructions should be retained for future reference.
- 3) Heed Warnings - All warnings on the product and in the operating instructions should be adhered to.
- 4) Follow Instructions - All operating and use instructions should be followed.
- 5) Cleaning - Unplug this product from the wall outlet before cleaning. Do not use liquid cleaners or aerosol cleaners. Use a damp cloth for cleaning.
- 6) Attachments - Do not use attachments not recommended by the product manufacturer as they may cause hazards.
- 7) Water and Moisture - Do not use this product near water - for example, near a bath tub, wash bowl, kitchen sink, or laundry tub; in a wet basement; or near a swimming pool; and the like.
- 8) Accessories - Do not place this product on an unstable cart, stand, tripod, bracket, or table. The product may fall, causing serious injury to a child or adult, and serious damage to the product. Use only with a cart, stand, tripod, bracket, or table recommended by the manufacturer, or sold with the product. Any mounting of the product should follow the manufacturer's instructions, and should use a mounting accessory recommended by the manufacturer.
- 9) A product and cart combination should be moved with care. Quick stops, excessive force, and uneven surfaces may cause the product and cart combination to overturn.
- 10) Ventilation - Slots and openings in the cabinet are provided for ventilation and to ensure reliable operation of the product and to protect it from overheating, and these openings must not be blocked or covered. The openings should never be blocked by placing the product on a bed, sofa, rug, or other similar surface. This product should not be placed in a built-in installation such as a bookcase or rack unless proper ventilation is provided or the manufacturer's instructions have been adhered to.
- 11) Power Sources - This product should be operated only from the type of power source indicated on the marking label. If you are not sure of the type of power supply to your home, consult your product dealer or local power company. For products intended to operate from battery power, or other sources, refer to the operating instructions.
- 12) Grounding or Polarization - This product may be equipped with a polarized alternating-current line plug (a plug having one blade wider than the other). This plug will fit into the power outlet only one way. This is a safety feature. If you are unable to insert the plug fully into the outlet, try reversing the plug. If the plug should still fail to fit, contact your electrician to replace your obsolete outlet. Do not defeat the safety purpose of the polarized plug.
- 13) Power-Cord Protection - Power-supply cords should be routed so that they are not likely to be walked on or pinched by items placed upon or against them, paying particular attention to cords at plugs, convenience receptacles, and the point where they exit from the product.
- 14) Lightning - For added protection for this product during a lightning storm, or when it is left unattended and unused for long periods of time, unplug it from the wall outlet. This will prevent damage to the product due to lightning and power-line surges.
- 15) Power lines - An outside antenna system should not be located in the vicinity of overhead power lines or other electric light or power circuits, or where it can fall into such power lines or circuits. When installing an outside antenna system, extreme care should be taken to keep from touching such power lines or circuits as contact with them might be fatal.
- 16) Overloading - Do not overload wall outlets, extension cords, or integral convenience receptacles as this can result in a risk of fire or electric shock.
- 17) Object and Liquid Entry - Never push objects of any kind into this product through openings as they may touch dangerous voltage points or short-out parts that could result in a fire or electric shock. Never spill liquid of any kind on the product.
- 18) Servicing - Do not attempt to service this product yourself as opening or removing covers may expose you to dangerous voltage or other hazards. Refer all servicing to qualified service personnel.
- 19) Damage Requiring Service - Unplug this product from the wall outlet and refer servicing to qualified service personnel under the following conditions:
  - a) When the power-supply cord or plug is damaged.
  - b) If liquid has been spilled, or objects have fallen into the product.
  - c) If the product has been exposed to rain or water.
  - d) If the product does not operate normally by following the operating instructions. Adjust only those controls that are covered by the operating instructions as an improper adjustment of other controls may result in damage and will often require extensive work by a qualified technician to restore the product to its normal operation.
  - e) If the product has been dropped or damaged in any way.
  - f) When the product exhibits a distinct change in performance - this indicates a need for service.
- 20) Replacement Parts - When replacement parts are required, be sure the service technician has used replacement parts specified by the manufacturer or have the same characteristics as the original part. Unauthorized substitutions may result in fire, electric shock, or other hazards.
- 21) Safety Check - Upon completion of any service or repairs to this product, ask the service technician to perform safety checks to determine that the product is in proper operating condition.
- 22) Heat - The product should be situated away from heat sources such as radiators, heat registers, stoves, or other products (including amplifiers) that produce heat.



## PRECAUTIONS

### Laser Safety

This unit employs a laser. Only a qualified service person should remove the cover or attempt to service this device, due to possible eye injury.

- CAUTION:** USE OF CONTROLS OR ADJUSTMENTS OR PERFORMANCE OF PROCEDURES OTHER THAN THOSE SPECIFIED HEREIN MAY RESULT IN HAZARDOUS RADIATION EXPOSURE.
- CAUTION:** VISIBLE AND INVISIBLE LASER RADIATION WHEN OPEN AND INTERLOCK DEFEATED. DO NOT STARE INTO BEAM.
- LOCATION:** INSIDE, NEAR THE DECK MECHANISM.

**FCC WARNING-** This equipment may generate or use radio frequency energy. Changes or modifications to this equipment may cause harmful interference unless the modifications are expressly approved in the manual. The user could lose the authority to operate this equipment if an unauthorized change or modification is made.

### RADIO-TV INTERFERENCE

This equipment has been tested and found to comply with the limits for a Class B digital device, pursuant to Part 15 of the FCC Rules. These limits are designed to provide reasonable protection against harmful interference in a residential installation. This equipment generates, uses, and can radiate radio frequency energy and, if not installed and used in accordance with the instructions, may cause harmful interference to radio communications. However, there is no guarantee that interference will not occur in a particular installation. If this equipment does cause harmful interference to radio or television reception, which can be determined by turning the equipment off and on, the user is encouraged to try to correct the interference by one or more of the following measures:

- 1) Reorient or relocate the receiving antenna.
- 2) Increase the separation between the equipment and receiver.
- 3) Connect the equipment into an outlet on a circuit different from that to which the receiver is connected.
- 4) Consult the dealer or an experienced radio/TV technician for help.

**This Class B digital apparatus complies with Canadian ICES-003.**

**CAUTION: TO PREVENT ELECTRIC SHOCK, MATCH WIDE BLADE OF PLUG TO WIDE SLOT, FULLY INSERT.**

Non-use periods - Turn off the unit when it is not in use. Unplug the unit from the household AC outlet if it is not to be used for a long time. Unplug the unit during lightning storms.

Please read this operating instructions carefully before using your DVD player, and keep it for future reference.

### Important

Use only discs marked with logos listed on page 6.

### Power Supply

The main power supply is engaged when the main plug is plugged in a 120V, 60Hz AC outlet. To operate the unit, press the **ON/STANDBY** button to turn on the unit.

### Warning

To avoid fire or electric shock, do not expose this unit to rain or moisture.

**WARNING:**  
**LIVE PARTS INSIDE.**  
**DO NOT REMOVE ANY SCREWS.**

### Installation Location

For safety and optimum performance of this unit:

- Do not stand the unit up vertically. Install the unit in a horizontal and stable position. Do not place anything directly on top of the unit. Do not place the unit directly on top of the TV.
- Shield it from direct sunlight and keep it away from sources of intense heat. Avoid dusty or humid places. Avoid places with insufficient ventilation for proper heat dissipation. Do not block the ventilation holes on the sides of the unit. Avoid locations subject to strong vibration or strong magnetic fields.
- Be sure to remove a disc and unplug the AC power cord from the outlet before carrying the unit.

### Cautions on Installation

Noise or disturbance of the picture may be generated if this unit or any other electronic equipment using microprocessors is used near a tuner or TV.

If this happens, take the following steps:

- Install this unit as far as possible from the tuner or TV.
- Set the antenna wires from the tuner or TV away from this unit's power cord and input/output connection cords.
- Noise or disturbance tends to occur particularly when using indoor antennas or 300Ω/ohms feeder wires. We recommend using outdoor antennas and 75Ω/ohms coaxial cables.

#### NOTE:

- For heat dispersal, do not install this equipment in a confined space such as a book case or similar unit.

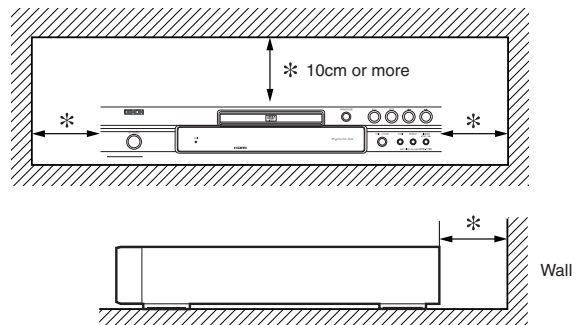

## PRECAUTIONS

### Dew Warning

Moisture condensation may occur inside the unit when it is moved from a cold place to a warm place, or after heating a cold room or under conditions of high humidity. Do not use the DVD Player at least for 2 hours until its inside is dry.

### Avoid the Hazards of Electrical Shock and Fire

- Do not handle the power cord with wet hands.
- Do not pull on the power cord when disconnecting it from AC wall outlet. Grasp it by the plug.
- If, by accident, water is spilled on this unit, unplug the power cord immediately and take the unit to our Authorized Service Center for servicing.

### Caution

- 1) Do not attempt to open the cabinet. There are no parts you can service inside. Refer all servicing to qualified service personnel.
- 2) Slot and openings in the cabinet and at the side or bottom are provided for ventilation. To ensure reliable operation and to protect the unit from overheating these opening must not be blocked or covered. Avoid enclosed spaces such as book cases unless proper ventilation is provided.

- 3) Keep the unit away from the radiator heat sources.
- 4) Avoid using near strong magnetic fields.
- 5) Do not push objects of any kind into this through the cabinet slot as they could touch current carrying parts or short circuit parts resulting in a fire or electric shock.
- 6) Never spill liquid of any kind on this unit.  
If liquid is spilled into the unit, consult qualified service engineer.
- 7) Use this unit in a horizontal (flat) position only.
- 8) This equipment is in Stand-by mode when it turns off whilst the power cord is connected.
- 9) Keep the set free from moisture, water and dust.
- 10) Handle the power cord carefully. Hold the plug when unplugging the cord.
- 11) All the safety cautions and operating instructions should be read before the DVD player is operated.
- 12) Use caution not to pinch your finger in the disc slot.
- 13) Do not put heavy objects on the AC power cord.
- 14) Keep the AC power cord away from heat appliances.
- 15) Be sure to remove a disc and unplug the AC power cord from the outlet before carrying the DVD player.
- 16) Do not put any pressure to the DVD player when carrying.
- 17) Do not use the DVD player outdoors.

## TABLE OF CONTENTS

■ <b>IMPORTANT SAFEGUARDS</b> .....	2	Fast Forward / Reverse Search .....	16
■ <b>PRECAUTIONS</b> .....	3	Slow Forward / Slow Reverse .....	16
Laser Safety .....	3	Step by Step Playback .....	16
Important .....	3	Zoom .....	16
Power Supply .....	3	Title / Chapter Search .....	16
Warning .....	3	By using the SEARCH MODE button .....	16
Installation Location .....	3	By using the SKIP buttons ◀◀▶▶ .....	16
Cautions on Installation .....	3	Track Search .....	17
Dew Warning .....	4	By using the SEARCH MODE button .....	17
Avoid the Hazards of Electrical Shock and Fire .....	4	By using the SKIP buttons ◀◀▶▶ .....	17
Caution .....	4	Time Search .....	17
■ <b>INTRODUCTION</b> .....	5	Marker Setup Screen .....	17
About Copyright .....	5	Repeat .....	17
Notice for the Progressive Scan Outputs .....	5	REPEAT TITLE / CHAPTER .....	17
Supplied Accessories .....	5	REPEAT TRACK / GROUP / ALL .....	17
Symbols Used in this Manual .....	5	A-B REPEAT .....	18
■ <b>ABOUT THE DISCS</b> .....	6	Program Playback .....	18
Playable Discs .....	6	Random Playback .....	18
■ <b>FEATURES</b> .....	7	MP3 / JPEG / WMA Playback .....	18
■ <b>FUNCTIONAL OVERVIEW</b> .....	8	Changing the On-Screen Display .....	20
FRONT PANEL .....	8	Slide Show Mode .....	21
REMOTE CONTROL .....	8	Dialog Speed .....	21
Tour of the Remote Control .....	9	Audio Language .....	21
Front Panel Display .....	10	Subtitle Language .....	21
Displays During Operation .....	10	Camera Angle .....	22
Loading the Batteries .....	10	Picture Control .....	22
Using a Remote Control .....	10	Stereo Sound Mode .....	22
■ <b>CONNECTIONS</b> .....	11	Virtual Surround .....	22
Description - Rear Panel .....	11	Black Level Setting .....	22
Connection to an Audio System .....	12	■ <b>DVD SETUP</b> .....	23
Connection to a TV (for video) .....	13	Language Setting .....	23
Connection to a TV with an HDMI compatible port .....	14	Display Setting .....	23
Connecting the AC Cord .....	14	Audio Setting .....	24
■ <b>DISC PLAYBACK</b> .....	15	Ratings Control .....	24
Basic Playback .....	15	RATING LEVEL .....	24
HDMI Setup .....	15	IF YOU FORGET THE PASSWORD .....	24
Brightness of the Front Panel Display .....	15	CONTROL LEVELS .....	25
TV TYPE .....	15	Others Setting .....	25
General Features .....	15	Reset to the Default settings (except for Ratings Control) .....	25
Disc Menus .....	15	Language Code List .....	25
Title Menu .....	15	■ <b>TROUBLESHOOTING GUIDE</b> .....	26
CALLING UP A MENU SCREEN DURING PLAYBACK .....	15	■ <b>SPECIFICATIONS</b> .....	27
Still / Pause .....	16	■ <b>MAINTENANCE</b> .....	27
Resume .....	16		

## INTRODUCTION

The serial number of this product may be found on the back of the DVD player. No others have the same serial number as yours. You should record the number and other vital information here and retain this book as a permanent record of your purchase to aid identification in case of theft. Serial numbers are not kept on file.

Date of Purchase	
Dealer Purchase from	
Dealer Address	
Dealer Phone No.	
Model No.	
Serial No.	

### About Copyright

Unauthorized copying, broadcasting, public performance and lending of discs are prohibited. This product incorporates copyright protection technology that is protected by U.S. patents and other intellectual property rights. Use of this copyright protection technology must be authorized by Macrovision, and is intended for home and other limited viewing uses only unless otherwise authorized by Macrovision. Reverse engineering or disassembly is prohibited.







U. S. Patent Nos, 4,631,603, 4,819,098, 4,907,093, 5,315,448 and 6,516,132.

### Notice for the Progressive Scan Outputs

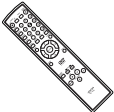
Consumers should note that not all high definition television sets are fully compatible with this product and may cause artifacts to be displayed in the picture. In case of picture problems with 480 (525) or 576 (625) progressive scan output, it is recommended that the user switch the connection to the 'standard definition' output. If there are questions regarding your TV set compatibility with this 480p (525p) or 576p (625p) DVD player, please contact our customer service center.

### Supplied Accessories

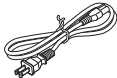
Please check to make sure the following items are included with the main unit in the carton.

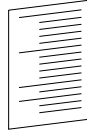
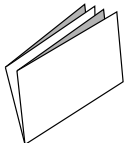
Remote control •• 1 	"AA" (R6P) batteries •••••• 2 	Audio cable•••• 1 	Video cable •• 1 	AC cord •••••• 1 	Operating Instructions •••••• 1 	Service Station List •••• 1 	Warranty Card••• 1 
--	---	--	---	--	---	--	---

### Symbols Used in this Manual

The following symbols appear below in some headings and notes in this manual, with the following meanings.

- DVD** : Description refers to playback of DVD-Video discs. (including DVD-R/RW discs)
- CD** : Description refers to playback of Audio CDs.
- MP3** : Description refers to playback of discs formatted with MP3.
- JPEG** : Description refers to viewing of JPEG discs.
- WMA** : Description refers to playback of discs formatted with WMA.

### A NOTE ABOUT RECYCLING

This product's packaging materials are recyclable and can be reused. Please dispose of any materials in accordance with your local recycling regulations.

Batteries should never be thrown away or incinerated but disposed of in accordance with your local regulations concerning chemical wastes.









#### Make your contribution to the environment!!!

- Used up batteries do not belong in the dust bin.
- You can dispose of them at a collection point for used up batteries or special waste. Contact your council for details.

## ABOUT THE DISCS

### Playable Discs

Playable discs	Mark (logo)	Region code	Recorded signals	Disc size	Disc types
DVD-Video *1, 2, 4		or	Digital video (MPEG2) MP3 WMA*8 Digital picture (JPEG)	 12 cm or 8 cm	
DVD-R DVD-RW *2, 3, 4, 5, 6, 7, 8					
Audio CD *2, 4		—			
CD-R CD-RW *2, 3, 4, 6, 7, 8	 	—			
*2, 3, 4, 6, 7	 				

- **Progressive Scan system**  
The progressive scan system provides less flickering and images in higher resolution than that of traditional 480i (525i), 576i(625i) or multi television signals through the interlace scan system.
- **TV Type**  
Use this to set your TV's video format. (MULTI, NTSC or PAL)
- **Dolby Digital Sound**  
By hooking up this player to a Multi-Channel Dolby Digital decoder, you can enjoy high-quality Dolby Digital Multi-channels surround sound as heard in the movie theaters.
- **DTS (Digital Theater System)**  
When this player is connected to the DTS decoder, you can enjoy Multi-channel surround system which reproduces the original sound as truthfully as possible. Multi-channel surround system is developed by DTS, Inc.
- **HDMI (High Definition Multimedia Interface)**  
You can enjoy clearer video output when connecting this player to a display equipment with an HDMI-compatible port.
- **Dialog Speed**  
Playback in slightly faster or slower speed while keeping the sound quality as in the normal playback. Dialog speed is available only on discs recorded in the Dolby Digital format.
- **Still/Fast/Slow/Step playback**  
Various playback modes are available including still pictures, fast forward/reverse, slow motion and step frames.
- **Still Mode**  
The resolution of pictures while in the still (pause) mode can be adjusted.
- **Random Playback for Audio CD, MP3, JPEG and WMA**  
This player can shuffle the playback order of tracks in random order.
- **Program Playback for Audio CD, MP3, JPEG and WMA**  
You can program the playback order of tracks in a desired order.
- **DVD menus in a desired language**  
You can display DVD menus in a desired language, if available on a DVD.
- **Auto Power Off**  
The power turns off automatically if there is no activity at the player or its remote for more than 30 minutes (refer to page 25).
- **Subtitles in a desired language**  
You can select a desired language for subtitles if that language is available on a disc.
- **Selecting a camera angle**  
You can select a desired camera angle if a disc contains sequences recorded from different angles.
- **Choices for audio language and sound mode**  
You can select a desired audio language and sound mode if different languages and modes are available on a disc.
- **Ratings Control (Parental lock)**  
You can set the control level to limit playback of discs which may not be suitable for children.
- **Automatic detection of discs**  
This player automatically detects if a loaded disc is DVD-Video, Audio CD, MP3, JPEG or WMA.
- **Playing back an MP3 disc**  
You can enjoy MP3 files which are recorded on DVD-R/RW or CD-R/RW.

- **Direct Search**  
You can search the desired title, chapter, and track with numeric button during playback or in stop mode.
- **On-screen display**  
Information about the current operation can be displayed on a TV screen, allowing you to confirm the currently active functions (such as program playback) using the remote control.
- **Dimmer**  
The brightness of the display can be adjusted.
- **Screen Saver**  
The screen saver program starts if there is no activity at the player or its remote for more than 5 minutes. The brightness of the display is darkened by 75%. The program is inactivated when there is any activity.
- **Picture Control**  
Picture Control adjusts Brightness, Contrast, Color, Gamma Correction and Sharpness of the specific display.
- **Search**  
Chapter search: Search for a desired chapter.  
Title search: Search for a desired title.  
Track search: Search for a desired track.  
Time search: Search for a desired time point or a title or a track.
- **Repeat**  
Chapter: Repeated playback of a chapter of the disc.  
Title: Repeated playback of a title of the disc.  
Track: Repeated playback of a track of the disc.  
All: Repeated playback of the entire disc. (exclude DVD)  
A-B: Repeated playback of a part between two points designated by user.  
Group: Repeated playback of a folder of the MP3/JPEG/WMA disc.
- **Zoom**  
2-time or 4-time magnified screen can be displayed.
- **Marker**  
Electric reference points designated by user can be called back.
- **Resume Playback**  
User can resume playback from the point at which the playback has been stopped.
- **Component Video Out Jacks**  
Jacks located on the back of the DVD Player which are used to send high-quality video to a TV via Component Video In Jacks.
- **Bit rate indication**
- **DRC (Dynamic Range Control)**  
You can control the range of sound volume.
- **Displaying a JPEG picture**  
Kodak Picture CDs can be played back. Still images stored in JPEG format on DVD-R/RW or CD-R/RW can also be played back.
- **Reproducing WMA data**  
You can enjoy WMA files which are recorded on DVD-R/RW or CD-R/RW.

Manufactured under license from Dolby Laboratories. "Dolby" and the double-D symbol are trademarks of Dolby Laboratories.

"DTS" and "DTS Digital Out" are registered trademarks of DTS, Inc.

"WMA" (Windows Media Audio) is an audio codec developed by Microsoft® in the United States of America.

## FUNCTIONAL OVERVIEW

FRONT

4 5 6/2

























REMOTE CONTROL

The buttons with circled numbers can only be operated with the remote control.



**Tour of the Remote Control**

Buttons on remote control work in different ways for DVD, Audio CD, MP3, JPEG and WMA:  
Refer to the following table for correct use.

	DVD	CD/MP3/JPEG/WMA
<b>POWER ON/OFF Buttons</b> 	<ul style="list-style-type: none"> <li>To switch the power between on and standby.</li> </ul>	<ul style="list-style-type: none"> <li>To switch the power between on and standby.</li> </ul>
<b>A-B REPEAT Button</b> 	<ul style="list-style-type: none"> <li>To mark a segment between A and B for repeated playback.</li> </ul>	<ul style="list-style-type: none"> <li>To mark a segment between A and B for repeated playback. (CD)</li> </ul>
<b>REPEAT Button</b> 	<ul style="list-style-type: none"> <li>To repeat playback of a title or chapter.</li> </ul>	<ul style="list-style-type: none"> <li>To repeat playback of a track or disc. (CD)</li> <li>To repeat playback of a track, group or disc. (MP3, JPEG, WMA)</li> </ul>
<b>RANDOM Button</b> 	<p>—</p>	<ul style="list-style-type: none"> <li>To play back tracks in random order.</li> </ul>
<b>MODE Button</b> 	<ul style="list-style-type: none"> <li>To set Picture Control.</li> <li>To set Black Level on/off.</li> <li>To activate the 3D sound (Virtual surround system).</li> <li>To set Dialog Speed.</li> </ul>	<ul style="list-style-type: none"> <li>To program a specific playback order.</li> <li>To activate the 3D sound (Virtual surround system). (CD, MP3, WMA)</li> <li>To activate the Slide Show mode (JPEG)</li> </ul>
<b>ZOOM Button</b> 	<ul style="list-style-type: none"> <li>To magnify part of the picture (x2/x4).</li> </ul>	<ul style="list-style-type: none"> <li>To magnify part of the picture (x2). (JPEG)</li> </ul>
<b>ANGLE Button</b> 	<ul style="list-style-type: none"> <li>To access various camera angles on the disc.</li> </ul>	<ul style="list-style-type: none"> <li>To rotate a picture. (JPEG)</li> </ul>
<b>SUBTITLE Button</b> 	<ul style="list-style-type: none"> <li>To access various subtitles on the disc.</li> </ul>	<p>—</p>
<b>AUDIO Button</b> 	<ul style="list-style-type: none"> <li>To access various audio functions on the disc.</li> </ul>	<ul style="list-style-type: none"> <li>To select STEREO, L-ch or R-ch. (CD)</li> </ul>
<b>DISPLAY Button</b> 	<ul style="list-style-type: none"> <li>To display the current disc or HDMI mode.</li> </ul>	<ul style="list-style-type: none"> <li>To display the current disc or HDMI mode.</li> </ul>
<b>SEARCH MODE Button</b> 	<ul style="list-style-type: none"> <li>To search for a chapter, title, time or marker.</li> <li>To return to a location on the disc rapidly.</li> </ul>	<ul style="list-style-type: none"> <li>To search for a track.</li> <li>To search for time or a marker. (CD)</li> <li>To return to a location on the disc rapidly.</li> </ul>
<b>OPEN/CLOSE Button</b> 	<ul style="list-style-type: none"> <li>To open or close the disc tray.</li> </ul>	<ul style="list-style-type: none"> <li>To open or close the disc tray.</li> </ul>
<b>Numeric Buttons</b> 	<ul style="list-style-type: none"> <li>To select a chapter or title directly.</li> </ul>	<ul style="list-style-type: none"> <li>To select a track directly.</li> </ul>
<b>CLEAR Button</b> 	<ul style="list-style-type: none"> <li>To clear the markers.</li> <li>To clear the numbers entered incorrectly.</li> <li>To cancel the A point for A-B Repeat.</li> </ul>	<ul style="list-style-type: none"> <li>To clear the markers. (CD)</li> <li>To clear the numbers entered incorrectly.</li> <li>To cancel the A point for A-B Repeat. (CD)</li> <li>To remove status number in program input.</li> </ul>
<b>MENU Button</b> 	<ul style="list-style-type: none"> <li>To call up the menu on a disc.</li> </ul>	<ul style="list-style-type: none"> <li>To call up the FILE LIST. (MP3, JPEG, WMA)</li> </ul>
<b>TOP MENU Button</b> 	<ul style="list-style-type: none"> <li>To call up the top menu on a disc.</li> </ul>	<ul style="list-style-type: none"> <li>To return to the first item in the highest hierarchy of the FILE LIST. (MP3, JPEG, WMA)</li> </ul>
<b>ENTER, Cursor Buttons</b> 	<ul style="list-style-type: none"> <li>To move the cursor and determine its position.</li> </ul>	<ul style="list-style-type: none"> <li>To move the cursor and determine its position.</li> </ul>
<b>RETURN Button</b> 	<ul style="list-style-type: none"> <li>To return to the previous operation in the setup menu.</li> </ul>	<ul style="list-style-type: none"> <li>To return to the previous operation in the setup menu.</li> </ul>
<b>SETUP Button</b> 	<ul style="list-style-type: none"> <li>To call up the setup menu.</li> </ul>	<ul style="list-style-type: none"> <li>To call up the setup menu.</li> </ul>
<b>SKIP Buttons</b> 	<ul style="list-style-type: none"> <li>To skip chapters/titles.</li> </ul>	<ul style="list-style-type: none"> <li>To skip tracks.</li> </ul>
<b>SEARCH Buttons</b> 	<ul style="list-style-type: none"> <li>To begin fast forward/reverse search or slow forward/slow reverse.</li> </ul>	<ul style="list-style-type: none"> <li>To begin fast forward/reverse search. (CD, MP3, WMA)</li> </ul>
<b>STOP Button</b> 	<ul style="list-style-type: none"> <li>To stop playback.</li> </ul>	<ul style="list-style-type: none"> <li>To stop playback.</li> </ul>
<b>PLAY Button</b> 	<ul style="list-style-type: none"> <li>To begin playback.</li> </ul>	<ul style="list-style-type: none"> <li>To begin playback.</li> </ul>
<b>STILL/PAUSE Button</b> 	<ul style="list-style-type: none"> <li>To pause playback.</li> <li>To advance playback frame by frame.</li> </ul>	<ul style="list-style-type: none"> <li>To pause playback.</li> </ul>

## FUNCTIONAL OVERVIEW

### Front Panel Display

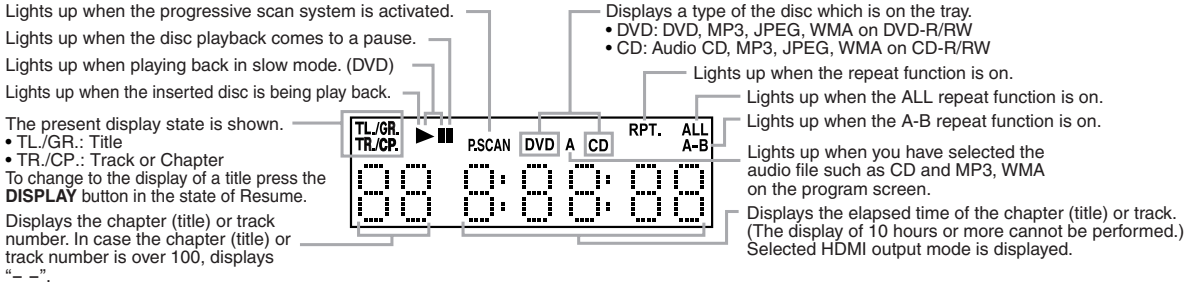

### Displays During Operation

	Power on
	No disc inserted or cannot read
	Tray open
	Tray closed
	Loading the disc
	Power off
	HDMI output mode (480p/576p) is selected (576p is displayed after 480p)
	HDMI output mode (720p) is selected
	HDMI output mode (1080i) is selected
	HDMI output mode (1080p) is selected
	HDMI output mode (OFF) is selected
	Program playback is set
	Program playback setting group (folder) is selected
	Program playback setting ALL CLEAR is selected
	Random playback is set

### Loading the Batteries

1. Open the battery compartment cover.
2. Insert two “AA” (R6P) batteries, with each one oriented correctly.
3. Close the cover.

### Using a Remote Control

- Keep in mind the following when using the remote control:
- Make sure that there are no obstacles between the remote control and the remote sensor on the unit.
  - Remote operation may become unreliable if strong sunlight or fluorescent light is shining on the remote sensor of the unit.
  - Remote control for different devices can interfere with each other. Avoid using remote control for other equipment located close to the unit.
  - Replace the batteries when you notice a fall off in the operating range of the remote control.
  - The maximum operable ranges from the unit are as follows.
    - **Line of sight:** approx. 23 feet (7m)
    - **Either side of the center:** approx. 16 feet (5m) within 30°
    - **Above:** approx. 16 feet (5m) within 15°
    - **Below:** approx. 10 feet (3m) within 30°

Description - Rear Panel

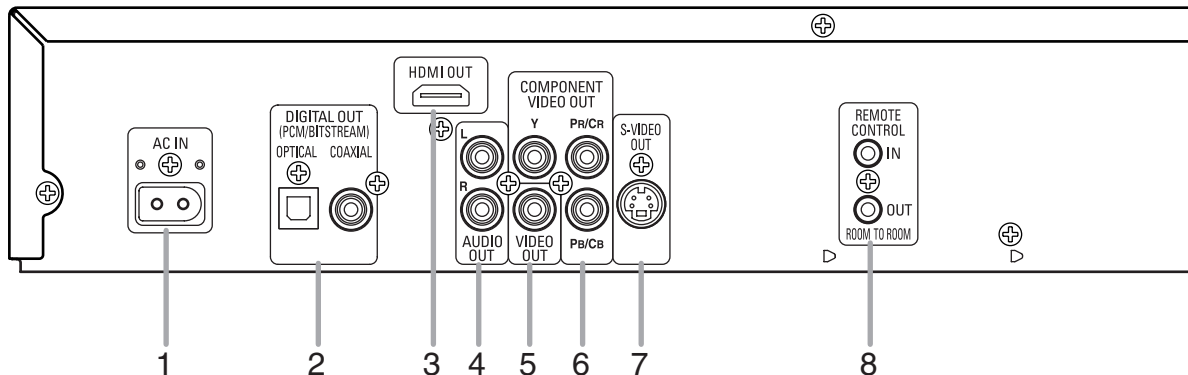

**1. AC IN Terminal**

Connects the AC cord to supply the power.

**2. DIGITAL OUT Jacks (OPTICAL/COAXIAL)**

Use either an optical or coaxial digital cable (commercially available) to connect to an AV amplifier with a built-in decoder (AV control center).

**3. HDMI OUT Jack**

Use a HDMI connection cable (commercially available) to connect to a display with an HDMI compatible port.

**4. AUDIO OUT Jacks**

Use an audio cable to connect to the Audio input jacks of A/V-compatible TV, wide screen TV or Stereo system.

**5. VIDEO OUT Jack**

Use a video cable to connect one of the jacks to Video input on your A/V-compatible TV or wide screen TV.

**6. COMPONENT VIDEO OUT Jacks**

Use a component video cable (commercially available) to connect these jacks if you have a TV with Component Video in jacks. These jacks provide C<sub>R</sub>/P<sub>R</sub>, C<sub>B</sub>/P<sub>B</sub> and Y video. Along with S-Video, Component Video provides the best picture quality.

**7. S-VIDEO OUT Jack**

Use an S-Video cable (commercially available) to connect this jack to the S-Video jack on your A/V-compatible TV or wide screen TV for a higher quality picture.

**8. REMOTE CONTROL IN/OUT Jacks**

Connecting the DENON Satellite Remote Control to these jacks enables you to operate more than one DENON components with one remote control.

**When using the DENON Satellite Remote Control,**

1. Connect the DENON Satellite Remote Control to the REMOTE CONTROL IN jack of this player. This allows you to operate this player with the Satellite Remote Control.
2. Connect another DENON component to the REMOTE CONTROL OUT jack of this player. This allows you to operate this player and the connected component with the same Satellite Remote Control.

**Selecting Progressive Scan (480p/576p or Interlaced 480i/576i) Playback**

- If your TV is compatible with progressive scanning (480p/576p), connect the TV to the COMPONENT VIDEO OUT jacks of the DVD player and set PROGRESSIVE to ON in the Display setting. Next, set your TV to the progressive scan mode. Refer to page 23 for instructions on changing the Display setting. P.SCAN will appear on the Display of the unit.
- If your TV is not compatible with progressive scanning, set PROGRESSIVE to OFF (refer to page 23). Make sure that P.SCAN on the display of the unit lights off.
- Use a commercially available adaptor if the video input jacks of your TV or monitor is the BNC type.

**What is Progressive Scanning?**

- Unlike conventional interlace scanning, the progressive scan system provides less flickering and images in higher resolution than that of traditional (480i/576i) television signals.

## Connection to an Audio System

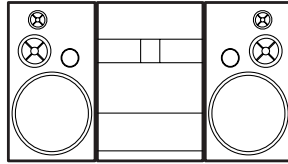

Stereo system

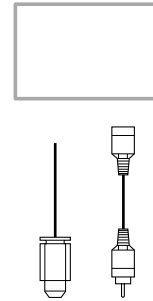
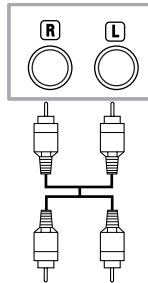

### NOTES (for Method 2 only):

- When using an AV amplifier with a built in decoder (AV control center), Dolby Digital, or DTS decoder as shown in the Method 2, set "DOLBY DIGITAL" or "DTS" to "BITSTREAM" accordingly for audio output in the setup mode (refer to page 24). Set it to "PCM" or "OFF" for the decoder that is not used currently. Playing back a DVD using incorrect settings may generate noise distortion, and may also damage the speakers.
- The audio source on a disc in a Dolby Digital Multi-channel surround format cannot be recorded as digital sound by an MD deck or DAT deck.
- Set "DOLBY DIGITAL" to "PCM" and "DTS" to "OFF" for audio output in the setup mode for connecting to an MD deck or DAT deck (refer to page 24).
- Harsh noise that could harm your ears or the speakers is generated when a DVD recorded in DTS is played while using a decoder, etc., that is not DTS-compatible.
- When playing a copyright-protected 96kHz PCM DVD, the digital sound will be down sampled at 48kHz, even if you set "LPCM SELECT" to "OFF" (refer to page 24).

Connection to a TV (for video)

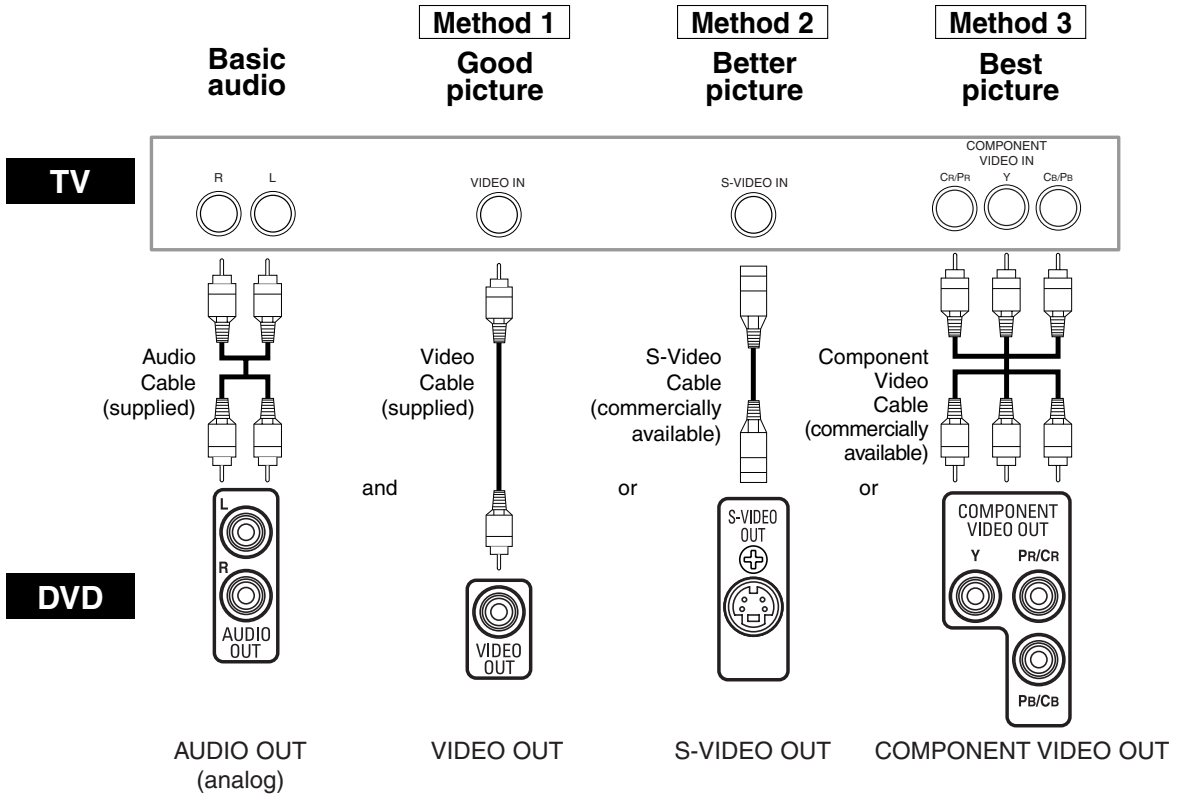

- **Method 1** DVD Player + TV with Video Input Jack
- **Method 2** DVD Player + TV with S-Video Input Jack
- **Method 3** DVD Player + TV with Component Video Input Jacks

**NOTES:**

- Connect the DVD player directly to a TV. If the Audio/Video cables are connected to a VCR, pictures may be distorted due to the copy protection system.
- S-Video output connector  
The video signals are divided into color (C) and brightness (Y) signals, achieving a clearer picture.  
If the TV is equipped with a S-Video input connector, we recommend connecting it to this unit's S-Video output connector using a commercially available S-Video connection cord.

**HOW TO CONNECT TO A TV WITHOUT AUDIO/VIDEO INPUT JACKS**

If your TV does not have RCA type audio and video input jacks it is still possible to connect this DVD player to your TV's 75-ohm coaxial antenna terminal using an optional Stereo Audio/Video RF Modulator, not included. Connect the audio and video outputs of the DVD player to the audio and video inputs on the RF Modulator, and then connect the coaxial output of the RF Modulator (usually marked "TO TV") to the 75 ohm coaxial antenna terminal on your TV. Follow the instruction supplied with the RF Modulator for more details.

If your TV's 75 ohm coaxial antenna terminal is already occupied by an antenna or cable box connection, remove that cable from your TV's antenna terminal and reconnect it to the coaxial antenna input terminal of the RF Modulator (usually marked "ANT IN"), then connect the RF modulator to your TV's antenna terminal as described above.

**NOTE:**

- The picture quality from DVD discs will not be as good if the DVD player is connected to the TV's antenna terminal through an RF Modulator.

## CONNECTIONS

### Connection to a TV with an HDMI Compatible Port

A simple 1-cable connection (using a commercially available cable) with a device having an HDMI (High-Definition Multimedia Interface) connector allows digital transfer of the digital images of DVD-Video and other sources.

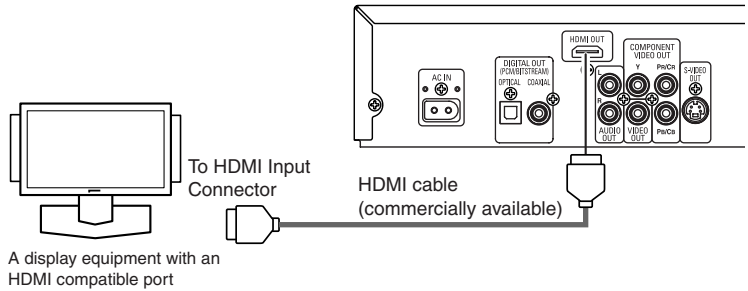

### Actual output modes by media

		DOLBY DIGITAL/DTS Setting	
Audio Recording Format		BITSTREAM *1	PCM or OFF
DVD-Video	Dolby Digital	Dolby Digital	2channel PCM
	DTS	DTS	—
	LPCM	2channel PCM	2channel PCM
Audio CD		2channel PCM	2channel PCM
MP3/WMA		2channel PCM	2channel PCM

\*1 If the connected equipment is not compatible with HDMI BITSTREAM, signals are output on PCM.

### Copyright protection system

To playback the digital video images of a DVD via an HDMI connection, it is necessary that both the player and the display equipment (or an AV amplifier) support a copyright protection system called HDCP (High-bandwidth Digital Content Protection System). HDCP is copy protection technology that comprises data encryption and authentication of the connected AV equipment.

This player supports HDCP. Please read the operating instructions of your display equipment (or AV amplifier) for more information.

\*HDMI: High-Definition Multimedia Interface

### NOTES:

- When using an HDMI-incompatible or HDCP-incompatible display equipment, the image will not be viewed properly.
- Among the devices that support HDMI, some devices can control other devices via the HDMI connector; however, this player cannot be controlled by another device via the HDMI connector.
- The audio signals from the HDMI connector (including the sampling frequency, the number of channels and bit length) may be limited by the equipment that is connected.
- Among the monitors that support HDMI, some do not support audio output (for example, projectors). In connections with equipment such as this, audio signals are not output from the HDMI output connector.
- When the set's HDMI connector is connected to a DVI-D compatible monitor (HDCP compatible) with an HDMI-DVI converter cable (commercially available), the signals are output in digital RGB.

**“HDMI, the HDMI logo and High-Definition Multimedia Interface are trademarks or registered trademarks of HDMI Licensing LLC.”**

### Connecting the AC Cord

After you made all necessary connections, connect the AC cord to the AC inlet. Then connect the AC cord to the AC outlet.

*Getting started*

Step by Step Playback

DVD

- 1 During playback, press the **STILL/PAUSE** button.
  - Playback will pause and sound will be muted.
- 2 The disc advances frame by frame each time the **STILL/PAUSE** button is pressed.
- 3 To exit step by step playback, press the **PLAY** button.



**NOTE:**

- On DVDs, set “STILL MODE” to “FIELD” on the display menu if pictures in the pause mode are blurred (refer to page 23).

DVD JPEG

This function allows you to enlarge the video image and to pan through the zoomed image.

- 1 Press the **ZOOM** button during playback.
  - Playback will continue.
- 2 Press the **ZOOM** button repeatedly to select a desired zoom factor: x2, x4 or off.
  - Only x2 zoom is available for JPEG.



- 3 Use the **Cursor** buttons (▲ / ▼ / ◀ / ▶) to move the zoomed picture across the screen.



- 4 To exit zoom mode, press the **ZOOM** button.

**NOTES:**

- Zoom function does not work while disc menu is shown.
- x4 zoom is not available on some discs.
- Navigation screen is not available on JPEG.
- You cannot pan through the zoomed picture on some JPEG files.

Slow Forward / Slow Reverse

DVD

- 1 During playback, press the **STILL/PAUSE** button.
- 2 Press the ◀◀ or ▶▶ button.
  - Slow motion playback will begin and sound will be muted.
- 3 Press the ◀◀ or ▶▶ button repeatedly to select a desired speed.
  - Slow forward or reverse speed is different depending on the disc. Approximate speed is 1 (1/16), 2 (1/8), and 3 (1/2).
- 4 To return to normal playback, press the **PLAY** button.

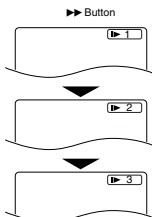

**NOTE:**

- On DVDs, set “STILL MODE” to “FIELD” on the Display menu if pictures in the slow playback mode are blurred (refer to page 23).



Track Search

CD MP3 JPEG WMA

There are two ways to begin playback an Audio CD, MP3, JPEG or WMA disc at a specific track.

By using the SEARCH MODE button

- Press the **SEARCH MODE** button.
  - The track search display appears.
- Within 30 seconds, select a desired track number using the **Numeric** buttons.
  - For the disc with less than 10 tracks, press the track number directly.
  - For discs with 10 or more but less than 100 tracks, to play back a single-digit track, press **0** first, then the track number (e.g. for track 3, press **0, 3**). To play back a double-digit track, press the track number.
  - For discs with 100 or more tracks, to play back a single- or a double-digit track, press **0** first, then the track number (e.g. for track 3, press **0, 0, 3**, and for track 26, press **0, 2, 6**). To play back a triple-digit track, press the track number.
  - Press the **CLEAR** button to erase the incorrect input.

NOTE:

- The **+10** button can also bring up the track search display except for the disc with less than 10 tracks. For such a disc, track search can be done by just pressing the track number.

By using the SKIP buttons

During playback, press the **SKIP** button to move to the next track. Press it repeatedly to skip to subsequent tracks. Press the **SKIP** button to go back to the beginning of the current track. Press it repeatedly to go to the previous tracks.

- Track number will appear briefly on the front panel display.
- If the **SKIP** button is pressed while the playback is paused, the playback will be paused again after skipping to the next track.

NOTE:

- The **SKIP** buttons are not available when playback is stopped.

Time Search

DVD CD

- Press the **SEARCH MODE** button until the time search screen appears on the TV screen.
- Within 30 seconds, enter a desired disc time point on the disc with the **Numeric** buttons.
  - Playback will start at the specified time.
  - For Time Search, "0" appears automatically when there is no need to enter a number. For example, "0:0:\_" appears in the time search screen if the total time of the disc is less than 10 minutes.
- Press the **CLEAR** button to erase an incorrect input.

Marker Setup Screen

DVD CD

You can use markers to memorize your favorite places on a disc.

- Press the **SEARCH MODE** button repeatedly until the display screen and Markers appear during playback.
- Press the **Cursor** buttons to select 1, 2, 3, 4, 5, 6, 7, 8, 9, or 10 and ensure that " : : : : : " appears in the display.

- When the disc reaches the point you want to remember, press the **ENTER** button.
  - The title or track and elapsed playback time will appear in the TV screen.
- To return to the Marker later, press the **SEARCH MODE** button repeatedly during playback and the **Cursor** buttons to choose a desired marker, then press the **ENTER** button.
- Press the **SEARCH MODE** or **RETURN** button to exit.

NOTES:

- Opening the disc tray, turning off the power or selecting AC at step 2 and pressing the **ENTER** button will erase all Markers.
- To clear a marker, using the **Cursor** buttons, position the cursor on to the marker number to be cleared and press the **CLEAR** button.
- You can mark up to 10 points.

Repeat

- The **REPEAT** button is available only during playback.

REPEAT TITLE / CHAPTER

DVD

To activate Repeat function, press the **REPEAT** button during playback.

- The repeat mode changes as described below every time you press the button.

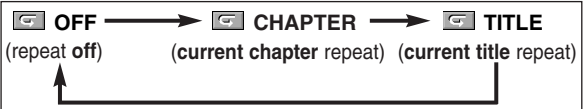

NOTES:

- The Repeat Title/Chapter setting will be cleared when moving to other title or chapter.
- Repeat playback does not function during A-B repeat playback.
- Repeat Title/Chapter is not available with some scenes.

REPEAT TRACK / GROUP / ALL

CD

To activate Repeat function, press the **REPEAT** button during playback.

- The repeat mode changes as described below every time you press the button.



NOTES:

- In the track repeat, the repeat setting will be cleared when moving to other track.
- Repeat playback does not function during A-B repeat playback.

MP3 JPEG WMA

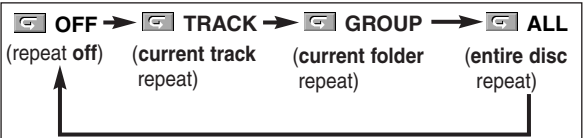

NOTE:

- In the track or group repeat, the repeat setting will be cleared when moving to other track or group.

## DISC PLAYBACK

### A-B REPEAT

DVD CD

- 1 Press the **A-B REPEAT** button at your chosen starting point.

- **A-** appears briefly on the TV screen.



- 2 Press the **A-B REPEAT** button again at your chosen end point.

- **A-B** appears briefly on the TV screen, and the repeat sequence begins.

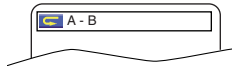

- 3 To exit the sequence, press the **A-B REPEAT** button.



#### NOTES:

- The A-B Repeat section can only be set within the current title (for DVD), or current track (for Audio CD).
- A-B Repeat is not available with some scenes on DVD.
- To cancel the A point which was set, press the **CLEAR** button.
- A-B Repeat playback does not function during title, chapter, track or all repeat playback.

### Program Playback

This function allows you to program a playback order of Audio CD, MP3, JPEG or WMA in a desired sequence.

CD

- 1 In stop mode, press the **MODE** button.

- The program screen will appear.

- 2 Press the **Cursor** buttons (**▲** or **▼**) to select a track, then press the **ENTER** button.

- Press the **CLEAR** button to erase the most recently entered track.

- 3 Press the **PLAY** button to start programmed playback.

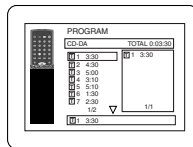

MP3

JPEG

WMA

- 1 In stop mode, press the **MODE** button.

- The program screen will appear.

- 2 Press the **Cursor** buttons (**▲** or **▼**) to select a group, then press the **ENTER** button.

- A track selection screen appears.

- 3 Press the **Cursor** buttons (**▲** or **▼**) to select a track, then press the **ENTER** button to save it in a program.

- Press the **CLEAR** button to erase the most recently entered track.

- The programmed track is displayed in the right-hand screen.

- If the entire program cannot be displayed on the screen, "▼" appears.

- Pressing the **Cursor** button (**◀**) will show a list of folders that belong to the hierarchy which is one-level higher than the currently selected folder.

- 4 Press the **PLAY** button to start programmed playback.

- Press the **RETURN** button, and the stop screen will show up with the program contents in memory.

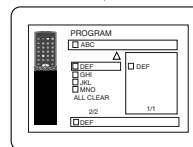
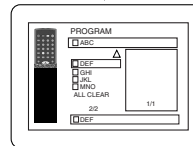
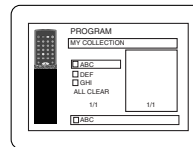

#### NOTES:

- Press the **STOP** button once and then the **PLAY** button again, playback will restart from the point where the **STOP** button was pressed. (Program continued.)
- Press the **STOP** button twice and then the **PLAY** button again, playback will restart from the first track in the usual way. Your program is still stored until either the disc tray is open or power is turned off.
- Up to 99 tracks can be entered.
- To erase tracks in the program all together, select ALL CLEAR at the bottom of the list at step 2. And, "A-CLEAR" is displayed on the front panel display at that time.
- To repeat the current track in the program, press the **REPEAT** button repeatedly until **TRACK** appears during playback. To repeat the entire program press the **REPEAT** button repeatedly until **ALL** appears during playback.
- If eight or more tracks were set in a program, use the **SKIP** **◀** or **▶** button to see all the tracks.
- When selecting the folder:
  - Press the **Cursor** button (**▶**) when you want to go to the next hierarchy.
  - Press the **Cursor** button (**◀**) when you want to go back to the previous hierarchy (except for the top hierarchy).
- Even if an inserted disc contains mixed MP3, JPEG and WMA files, Program function allows 99 tracks in combination of MP3, JPEG and WMA files.
- The front panel display has blinked while setting the program playback.

### Random Playback

CD

MP3

JPEG

WMA

This function shuffles the playback order of tracks instead of playback in the original sequence.

- 1 In stop mode, press the **RANDOM** button.

- The random screen will appear.

- 2 Press the **PLAY** button to start random playback.

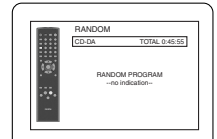

<Example: CD>

#### NOTES:

- To repeat the current track in the random selection, press the **REPEAT** button repeatedly until **TRACK** appears during playback. To repeat the entire random selection press the **REPEAT** button repeatedly until **ALL** appears during playback.
- You cannot go back to the previous track during random playback.
- For a disc containing mixed MP3, JPEG and WMA files, random playback of those files will be performed.
- "SHUFFLE" is displayed on the front panel display at step 1.

### MP3 / JPEG / WMA Playback

MP3

JPEG

WMA

When a DVD-R/RW or CD-R/RW disc with MP3, JPEG or WMA files is inserted in the DVD player, the file list will appear automatically on the TV screen. The number of tracks is also displayed on the front panel.

- 1 Press the **Cursor** buttons (**▲** or **▼**) to select the desired group (folder) or track.
  - To return to the previous screen, press the **Cursor** button (**◀**).
  - If a group (folder) is selected, press the **Cursor** button (**▶**) or **ENTER** button to go on to the track selection screen. Press the **Cursor** buttons (**▲** or **▼**) to choose a track, then press the **PLAY** or **ENTER** button.
  - If a track is selected, press the **PLAY** or **ENTER** button to start playing back tracks. The selected track and the subsequent tracks will be played back.

- When selecting the folders
    - Press the **Cursor** button (▶) when you want to go to the next hierarchy.
    - Press the **Cursor** button (◀) when you want to go back to the previous hierarchy (except for the top hierarchy).
  - Press the **TOP MENU** button to return to the first item.
- 2 Press the **STOP** button to stop playback.

**NOTES:**

- Folders are known as Groups; files are known as Tracks.
- A symbol of [ ] is shown on the top of the group name.
- A symbol of [ ] is shown on the top of MP3 files.
- A symbol of [ ] is shown on the top of JPEG files.
- A symbol of [ ] is shown on the top of WMA files.
- Maximum of 255 folders can be recognized.
- Maximum of 999 files can be recognized.
- Up to 8 hierarchies can be recognized.
- If the track extends beyond the scope of screen, a down arrow “▼” appears, indicating that the user can view another part on the previous page. The current page number and the number of total pages are shown on the left of the down arrow “▼”.
- If no MP3, JPEG or WMA files are found in the group, the group is not displayed.
- The DVD player can reproduce data recorded as per ISO 9660 Level 1, Level 2 or Joliet on the disc.
- It can also run a disc on which data is recorded in a multi-session.
- For more details of recording systems, refer to the instruction manual for the DVD-R/RW or CD-R/RW drive or the writing software.
- For MP3 and WMA files recorded in Variable Bit Rate (VBR), the unit may not display the actual elapsed time.

This player recommends the use of files recorded at the following specifications:

Applicable MP3 file		Remarks
Sampling frequency	44.1kHz 48kHz	• It is prohibited to record MP3 sound on a digital device when the connection is made digitally.
Type	MPEG1 audio layer 3	• MP3 files recorded at fixed bit rate of 32 kbps or higher are recommended.
Applicable JPEG file		Remarks
Size of image	Upper limit: 6300x5100 dots Lower limit: 32x32 dots	• A JPEG image that extends beyond the screen is reduced so that it will be displayed within the screen.
Applicable WMA file		Remarks
Sampling frequency	44.1kHz 48kHz	• Those frequencies are applicable to WMA version 9.
Bit rate	48–192kbps	• Ensure that the copyright function is set to off when preparing a WMA disc.
Type	WMA version 9	• A prohibition “disable” symbol will appear if the user attempts to run a non-reproducible file such as copyright-protected. • Recorded in multi-channel format cannot be played back.

**Information on MP3, JPEG and WMA discs**

- This DVD player can play back images and sounds from data recorded in MP3 and JPEG formats on DVD-R/RW and CD-R/RW discs.
- A file with an extension of “.mp3 (MP3)” is called an MP3 file.
- A file with an extension of “.jpg (JPG)” or “.jpeg (JPEG)” is called a JPEG file.  
The DVD player can run an image file conforming to the Exif specification. Exif is a file format, Exchangeable Image File format established by Japanese Electronic Industry Development Association (JEIDA).
- A file with an extension of “.wma (WMA)” is called a WMA file.
- Files whose extension is other than “.mp3 (MP3)”, “.jpg (JPG)” and “.jpeg (JPEG)” or “.wma (WMA)” will not be listed on the MP3, JPEG or WMA menu.
- If the file is not recorded in MP3, JPEG or WMA format, noise may be produced even if the file extension is either “.mp3 (MP3)”, “.jpg (JPG)”, “.jpeg (JPEG)” or “.wma (WMA)”.
- The name of group and track can be displayed up to 25 characters. Unrecognizable characters will be replaced with asterisks. The ninth and deeper hierarchies cannot be displayed.
- Unplayable groups or tracks may be displayed depending on the recording conditions.
- If the **TOP MENU** button is pressed when a file list is displayed, the first item will be highlighted.

**Kodak Picture CD**

The DVD player can also run JPEG files stored on Kodak Picture CDs. You can enjoy picture images on the television set by playing back the Picture CDs. This unit conform to ver. 7.0 of Kodak Picture CD. For details of Kodak Picture CD, contact a shop that provide developing service of Kodak Inc.

- 1 When Kodak Picture CD is inserted in the DVD Player, Kodak Picture CD menu appear automatically on the TV screen.

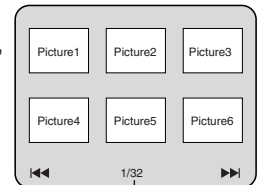

- If all menu items cannot be displayed on the screen scope, “▶▶” appears at the right bottom of the screen, indicating that the user can view remaining items on the next page. “◀◀” appears, it indicates that the user can view other items on the previous page. The track number of the currently highlighted item and the total tracks are shown at the center bottom of the screen.
- If “▶▶” is shown at the right bottom, use the **SKIP ▶▶▶** button to view the next page. If “◀◀” is shown at the left bottom, use the **SKIP ◀◀◀** button to view the previous page.
- It may take some time until all menu items are displayed on the menu screen.

- 2 Press the **Cursor** buttons (▲ / ▼ / ◀ / ▶), select a desired track to be played back, then press the **PLAY** or **ENTER** button.

- If a Kodak Picture CD file is selected, an image will be played back from the selected track and go to the next one in turn.

- 3 Press the **STOP** button, to stop playback.

**NOTES on JPEG and Kodak Picture CD:**

- A track is displayed for 5 or 10 seconds and then the next track is displayed.
- Every press on the **ANGLE** button will turn the image clockwise by 90 degrees when an image is displayed.
- To change the size of the playback image, press the **MODE** button twice. The size change mode appears on top of the TV screen during playback. Then press the **Cursor** buttons (◀ or ▶) or **ENTER** button to switch between **NORMAL** (100%) and **SMALL** (95%).

## DISC PLAYBACK

- Progressive JPEGs (JPEG files saved in the progressive format) will not be played back on this DVD player.
- High resolution JPEG files take longer to be displayed.
- The size change mode may have no effect on some files (e.g. files with a small picture size).
- In stop mode, press the **MENU** button, Kodak Picture CD menu appears.

### NOTES on WMA:

- The DVD player can reproduce data recorded as ISO 9660 level 2 with 31 characters file name included punctuation marks. The name of file can be displayed up to 25 characters.
- Maximum of 8 subfolders can be recognized.
- It can also be displayed tag information of WMA at least 64 characters.
- A file with an extension of Joliet as Unicode format in up to 64 characters can be recognized.
- This unit cannot play back copyright protected WMA files.

### Changing the On-Screen Display

You can check information about the current disc by pressing the **DISPLAY** button on the remote control.

#### DVD

- 1 Press the **DISPLAY** button during playback.
  - Current chapter number/total chapters, elapsed time and remaining time of the current chapter, and current playback status will be displayed.
- 2 Press the **DISPLAY** button again.
  - Current title number/total titles, elapsed time and remaining time of the current title, and current playback status will be displayed.
- 3 Press the **DISPLAY** button for the third time.
  - The bit rate (the amount of video data currently being read) and current playback status will be displayed.
  - Current repeat setting appears on the display bar only when the repeat setting is active.  
(◁ C: Chapter repeat/ ▷ T: Title repeat/A ▷ B: A-B repeat)
  - If you are playing back a two-layered disc, the layer number will also be displayed.  
(L0: Layer 0 is played back. L1: Layer 1 is played back.)
- 4 Press the **DISPLAY** button again.
  - Current HDMI status will be displayed during the HDMI output mode. (Refer to NOTE FOR HDMI DISPLAY on this page.)
- 5 Press the **DISPLAY** button again to exit.

#### CD

- 1 Press the **DISPLAY** button during playback.
  - Current track number/total tracks, elapsed time and remaining time of the current track, and current playback status will be displayed.
  - Current repeat setting appears on the display bar only when the Repeat setting is active.  
(▷ T: Track repeat/▷ A: All tracks repeat/A ▷ B: A-B repeat)
- 2 Press the **DISPLAY** button again.
  - Current track number/total tracks, elapsed time and remaining time of the entire disc, and current playback status will be displayed.
  - Current repeat setting appears on the display bar only when the Repeat setting is active.  
(▷ T: Track repeat/▷ A: All tracks repeat/A ▷ B: A-B repeat)
  - When you are playing back a disc in program or random mode, **PROGRAM** (or **RANDOM**) will be displayed.
- 3 Press the **DISPLAY** button again.
  - During program or random playback, each playback status will be displayed when you press the **DISPLAY** button. Then press the **DISPLAY** button again.
  - Current HDMI status will be displayed during the HDMI output mode. Refer to NOTE FOR HDMI DISPLAY on this page.
- 4 Press the **DISPLAY** button again to exit.

#### MP3 JPEG

- 1 Press the **DISPLAY** button during playback.
  - Current file name will be displayed.
- 2 Press the **DISPLAY** button.
  - Current track number/total tracks and elapsed time (MP3) will be displayed.
  - Current repeat setting appears only when the Repeat setting is active.  
(▷ T: Track repeat/▷ A: All (disc) repeat/▷ G: Group repeat)
  - When you are playing back a disc with MP3 or JPEG files in program or random mode, **PROGRAM** (or **RANDOM**) will be displayed.
- 3 Press the **DISPLAY** button again.
  - During program or random playback, each playback status will be displayed when you press the **DISPLAY** button. Then press the **DISPLAY** button to exit.
- 4 Press the **DISPLAY** button again.
  - Current HDMI status will be displayed during the HDMI output mode. (Refer to NOTE FOR HDMI DISPLAY on this page.)
- 5 Press the **DISPLAY** button again to exit.

#### WMA

- 1 Press the **DISPLAY** button during playback.
  - Current file name will be displayed.
- 2 Press the **DISPLAY** button again.
  - Title name based on tag information of currently played-back file will be displayed.
- 3 Press the **DISPLAY** button for the third time.
  - Artist name based on tag information of currently played-back file will be displayed.
- 4 Press the **DISPLAY** button again.
  - Current track number/total tracks and elapsed time will be displayed.
  - Current repeat setting appears only when the Repeat setting is active.  
(▷ T: Track repeat/▷ A: All (disc) repeat/▷ G: Group (folder) repeat)
  - When you are playing back a disc in program or random mode, **PROGRAM** (or **RANDOM**) will be displayed.
- 5 Press the **DISPLAY** button again.
  - During program or random playback, each playback status will be displayed when you press the **DISPLAY** button. Then press the **DISPLAY** button to exit.
- 6 Press the **DISPLAY** button again.
  - Current HDMI status will be displayed during the HDMI output mode. (Refer to NOTE FOR HDMI DISPLAY on this page.)
- 7 Press the **DISPLAY** button again to exit.

### NOTE:

- If the file does not contain tag information, **NOT AVAILABLE** will be displayed.

### NOTE FOR HDMI DISPLAY:

- The displayed HDMI status are as follows:
  1. Information for image output/Resolution of image
  2. Sound output format
  3. Maximum number of audio channels that can be accepted by the connected equipment



**NOTES:**

- The sound mode cannot be changed during playback of discs not recorded in double sound.
- Some discs allow to change audio language setting on the disc menu. (Operation varies between discs. Refer to the manual accompanying the disc.)
- Pressing the **AUDIO** button may not work on some DVDs with multiple audio languages (e.g. DVDs which allow to change audio language setting on the disc menu).
- If you choose a language that has a three-letter language code, the code will be displayed every time you change the Audio Language setting. If you choose any other languages, '---' will be displayed instead (refer to page 25).
- Audio Language selection cannot be made during Dialog Speed.
- DTS sound is output only from the digital audio outputs.
- If the disc has no audio language, 'NOT AVAILABLE' will be displayed.

**Subtitle Language**

**DVD**

The DVD player allows you to select a subtitle language (if multiple languages are available) during DVD playback.

- 1 Press the **SUBTITLE** button during playback.
- 2 Press the **SUBTITLE** button repeatedly to select your desired subtitle language.
  - The selected language will be displayed on the display bar at the top of the screen.
  - Press the **Cursor** buttons (◀ or ▶) to turn on or off subtitles during playback.

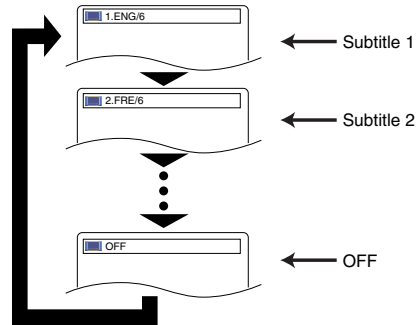

- 3 To turn off subtitles, press the **SUBTITLE** button repeatedly until OFF appears.

**NOTES:**

- Some discs allow subtitle language setting on the disc menu. (Operation varies between discs. Refer to the manual accompanying the disc.)
- Pressing the **SUBTITLE** button may not work on some DVDs with multiple subtitle languages (e.g. DVDs which allow subtitle language setting on the disc menu).
- If your desired language is not shown after pressing the **SUBTITLE** button several times, the disc does not have subtitles in that language.
- If you choose a language that has a three-letter language code, the code will be displayed every time you change the Subtitle Language setting. If you choose any other languages, '---' will be displayed instead (refer to page 25).
- If the disc has no subtitle language, 'NOT AVAILABLE' will be displayed.

**Audio Language**

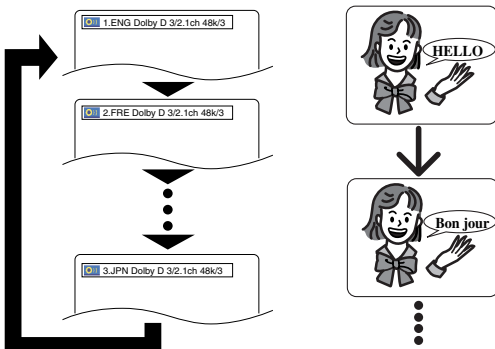

## DISC PLAYBACK

### Camera Angle

DVD

Some DVD discs contain scenes which have been shot simultaneously from various angles. You can change the camera angle when the (  ) mark appears on the screen.

- 1 Press the **ANGLE** button during playback.
  - The selected angle will be displayed on the display bar at the top of the screen.
- 2 Press the **ANGLE** button repeatedly to select your desired angle.

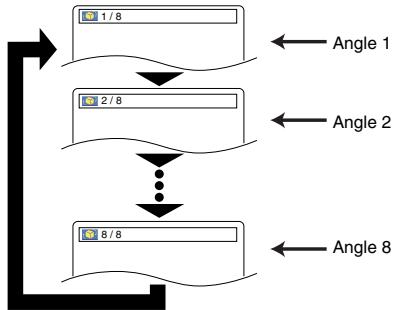

#### NOTE:

- If the "ANGLE ICON" setting is "OFF" in the Others menu, the (  ) will not appear (refer to page 25).

### Picture Control

DVD

Picture Control adjusts Brightness, Contrast, Color, Gamma Correction and Sharpness of the specific display.

- 1 During playback, press the **MODE** button. 
- 2 Press the **Cursor** buttons (▲ or ▼) to switch among items.
- 3 Press the **ENTER** button or the **Cursor** buttons (◀ or ▶) to adjust the selected item.
  - -6, -5, -4, -3, -2, -1, 0, +1, +2, +3, +4, +5, +6 can be selected.
- 4 To return to normal playback, press the **RETURN** button.

#### NOTES:

- The default settings for all items in Picture Control are "0".
- The setting display will disappear in 10 seconds of no use.
- This function cannot be used during Dialog Speed (refer to page 21).
- If you return all items to the default settings, select "INITIALIZE" at step 2.

### Stereo Sound Mode

CD

- 1 Press the **AUDIO** button repeatedly during playback to select your desired sound mode.

STEREO - both right and left channels are active (stereo)  
L-ch - only left channel is active  
R-ch - only right channel is active

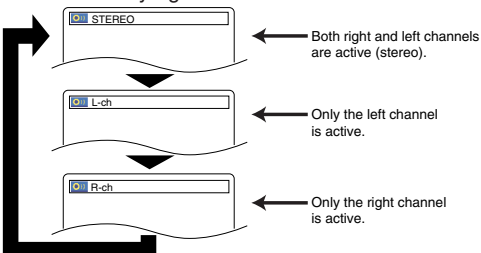

#### NOTE:

- Stereo sound mode will not be changed when playing DTS CD.

### Virtual Surround

DVD

CD

MP3

WMA

You can enjoy stereo phonic virtual space through your existing 2 channel stereo system.

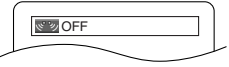
- 1 During playback, press the **MODE** button repeatedly until the Virtual Surround setting appears. 
- 2 Press the **ENTER** button to set it 1(Natural effect), 2(Emphasized effect) or OFF.
- 3 Press the **RETURN** button to exit.

#### NOTES:

- Select Virtual Surround OFF or lower the volume if the sound is distorted.
- Virtual Surround will not be effective if the sound mode is set to something other than "STEREO" (for Audio CD playback only).
- This function cannot be used during Dialog Speed (refer to page 21).

### Black Level Setting

DVD

Adjust the Black Level Setting to make the black parts of the picture as bright as you prefer.

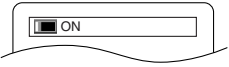
- 1 During playback, press the **MODE** button repeatedly until Black Level setting appears. 
- 2 Press the **ENTER** button to switch ON/OFF.  
ON (Default) : Makes the dark parts brighter.  
OFF : Shows the original picture as recorded.
- 3 Press the **RETURN** button to exit.

#### NOTE:

- This function cannot be used during Dialog Speed (refer to page 21).

In Setup menu, QUICK mode, CUSTOM mode and INITIALIZE mode (refer to pages 23-25) are available. QUICK mode consists of the setting menus frequently used, and they are accompanied with **QUICK** mark. You can make all settings in CUSTOM mode.

**Language Setting**

Language options are not available with some discs.

- 1 Press the **SETUP** button in stop mode.
- 2 Press the **Cursor** buttons (◀ or ▶) to select **CUSTOM**, then press the **ENTER** button.
  - The custom mode will appear.
- 3 Press the **Cursor** buttons (◀ or ▶) to select **LANGUAGE**, then press the **ENTER** button to confirm.
- 4 Press the **Cursor** buttons (▲ or ▼) to select an item, then press the **ENTER** button.

**DIALOG (Default : ORIGINAL)**

- Sets the audio language.

**SUBTITLE (Default : OFF)**

- Sets the subtitle language.

**DISC MENU (Default : ENGLISH)**

- Sets the language for DVD Menu.

**OSD (Default : ENGLISH) QUICK**

- Sets the language for the On-Screen display.
- 5 Press the **Cursor** buttons (▲ or ▼) to select a setting, then press the **ENTER** button.
    - If **OTHER** is selected in the **DIALOG**, **SUBTITLE** or **DISC MENU**, press four-digit number to enter the code for the desired language (refer to the language code list on page 25).
    - Only the languages supported by the disc can be selected.
  - 6 Press the **SETUP** button to exit and activate the new settings.

**NOTE:**

- Language Setting for **DIALOG** and **SUBTITLE** may not be available with some discs. Then use the **AUDIO** and **SUBTITLE** buttons. Details are on page 21.

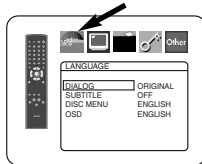

- **AUTO:** Automatically selects the best resolution setting (FRAME or FIELD) based on the data characteristics of the pictures.
- **FIELD:** Select **FIELD** when the pictures are still unstable even if **AUTO** is selected. **FIELD** stabilizes the pictures, although the picture quality may become coarse due to the limited amount of data.
- **FRAME:** Select **FRAME** to display relatively motionless pictures in higher resolution. **FRAME** improves the picture quality, although it may destabilize the pictures due to simultaneous output of two field data.

**TV TYPE (Default: MULTI)**

- Press the **Cursor** buttons (▲ or ▼) to select a setting, then press the **ENTER** button.
- Select a video system setting between **MULTI**, **NTSC** and **PAL**.
- **NTSC:** Select this when your TV's video format is **NTSC**. If **NTSC** is selected, output format is fixed to **NTSC**.
- **PAL:** Select this when your TV's video format is **PAL**. If **PAL** is selected, output format is fixed to **PAL**.
- **MULTI:** Automatically selects the suitable video out system (**PAL/NTSC**) according to the format of the inserted disc.
  - For the discs recorded with **NTSC** system, the **NTSC** signal will be output and pictures of the discs can be viewed on an **NTSC** or **Multi** system TV.
  - For the discs recorded with **PAL** system, the **PAL** signal will be output and pictures of the discs can be viewed on a **PAL** system TV.

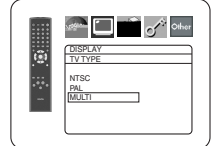

**NOTE:**

- If the **AC** power cord is disconnected while the unit is turned on, the video format of opening screen is altered. To keep the format, turn the unit off before unplugging the **AC** power cord.

**PROGRESSIVE (Default: OFF) QUICK**

- Press the **Cursor** buttons (▲ or ▼) for set **PROGRESSIVE** to **ON** or **OFF**, then press the **ENTER** button.
- The setting will be effective when you exit the setup screen by pressing **SETUP**.
- When **PROGRESSIVE** is **ON**, **PSCAN** appears on the DVD player's display after you exit the setup screen.
- Refer to page 11 for more details.

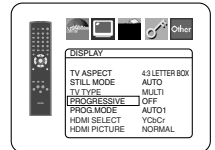

**PROG.MODE (Default: AUTO1)**

- Press the **Cursor** buttons (▲ or ▼) to select a setting (**AUTO1**, **AUTO2**, or **VIDEO**), then press the **ENTER** button.
- For **HDMI** or **Component Video** connection, this function allows you to select the image output, depending on the base material (video or film) of the recorded DVD images, when **PROGRESSIVE** is **ON**.
- **AUTO1:** Automatically selects the best image output (**AUTO2** or **VIDEO**) based on the information of data stream.
- **AUTO2:** A combination of the top and bottom fields is output as one-frame image.
- **VIDEO:** Either of top or bottom field is output for one-frame image.

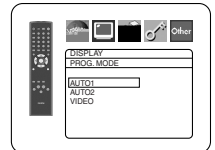

**Display Setting**

You can change certain aspects of the DVD display screens, still mode setting, Progressive and HDMI settings.

- 1 Press the **SETUP** button in stop mode.
- 2 Press the **Cursor** buttons (◀ or ▶) to select **CUSTOM**, then press the **ENTER** button.
  - The custom mode will appear.
- 3 Press the **Cursor** buttons (◀ or ▶) to select **DISPLAY**, then press the **ENTER** button to confirm.
- 4 Press the **Cursor** buttons (▲ or ▼) to select an item, then press the **ENTER** button.

**TV ASPECT (Default : 4:3 LETTER BOX) QUICK**

- Press the **Cursor** buttons (▲ or ▼) for an item selection, then press the **ENTER** button.
- Select **4:3 LETTER BOX** for a black bars appears on top and bottom of the screen.
- Select **4:3 PAN & SCAN** for a full height picture with both sides trimmed.
- Select **16:9 WIDE** if a wide-screen TV is connected to the DVD player.
- Select **4:3 SQUEEZE** when the TV screen is too large horizontally at **16:9 WIDE** setting and when it is impossible to adjust the screen size using the TV's controls.

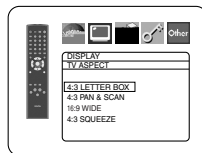
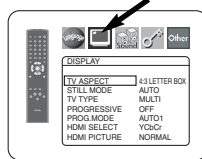

**STILL MODE (Default : AUTO)**

- Press the **Cursor** buttons (▲ or ▼) for an item selection (**AUTO**, **FIELD**, or **FRAME**), then press the **ENTER** button.
- This function allows you to adjust picture resolution and quality in still mode.
- An individual picture on TV screen is called as "frame", which consists of two separate images called as "field". Some pictures may be blurred at the **AUTO** setting in still mode due to their data characteristics.

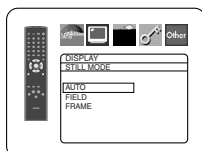

## DVD SETUP

### HDMI SELECT (Default: YCbCr)

- Select an HDMI output mode between YCbCr and RGB.
- When the connected equipment is not compatible with YCbCr, HDMI signal is output as RGB regardless of the setting.

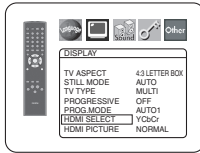

### HDMI PICTURE (Default: NORMAL)

- Select a HDMI picture mode between NORMAL and ENHANCED.
- Select ENHANCED if the black-white contrast is not clear.
- This setting is effective only for HDMI RGB output.

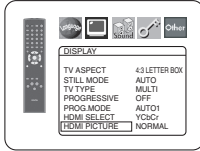

**5** Press the **SETUP** button to exit and activate the new settings.

#### NOTE:

- Be sure to press the **SETUP** button, or the setting will not work.

## Audio Setting

You can change some Audio settings. It only affects during the playback of DVD discs.

- 1 Press the **SETUP** button in stop mode.
- 2 Press the **Cursor** buttons (◀ or ▶) to select **CUSTOM**, then press the **ENTER** button.
  - The custom mode will appear.
- 3 Press the **Cursor** buttons (◀ or ▶) to select **AUDIO**, then the **ENTER** button to confirm.
- 4 Press the **Cursor** buttons (▲ or ▼) button to select an item, then press the **ENTER** button.

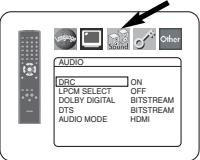

### DRC (Dynamic Range Control) (Default: ON)

- DRC function compresses the range of sound volume.
- DRC function is available only on the discs that are recorded in the Dolby Digital format.

### LPCM SELECT (Default: OFF)

- Set to ON when outputting in 48kHz.
- This function is available only on digital outputting of a disc recorded in 96kHz.
- When the HDMI sound is output, the setting is disregarded.

#### When playing disc with copyright protection

- The sound will be down sampled at 48kHz, even if you set to OFF.

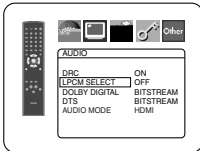
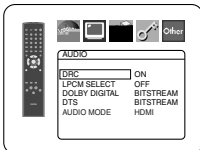

### DOLBY DIGITAL (Default: BITSTREAM) QUICK

- Set to BITSTREAM when the player is connected to a Dolby Digital decoder.
- This function is effective only for the COAXIAL, OPTICAL and HDMI connections.

#### BITSTREAM:

- For HDMI connection, if the connected equipment is not compatible with the Dolby Digital BITSTREAM, the signals are output as PCM regardless of the setting.

PCM: Convert Dolby Digital to PCM.

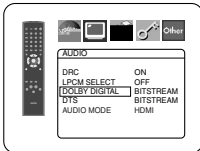

### DTS

#### (Default: BITSTREAM) QUICK

- Set to BITSTREAM when the unit is connected to a DTS decoder.

#### BITSTREAM:

DTS signals are output as Bitstream.

- For HDMI connection, if the connected equipment is not compatible with the DTS Bitstream, the signals are not output regardless of the setting.

OFF: No DTS sound will be output.

- DTS sound is output only from digital audio outputs.

### AUDIO MODE (Default: HDMI)

- Set to HDMI when outputting the HDMI sound.
- Set to ANALOG when not outputting the HDMI sound.

**5** Press the **SETUP** button to exit and activate the new settings.

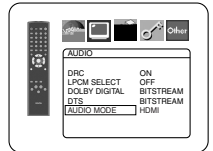
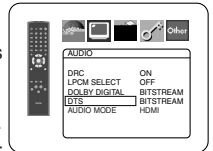

## Ratings Control

Ratings Control allows you to set a limit, which prevents your children from viewing inappropriate materials on DVDs. A four-digit password that you establish will give you the control.

### RATING LEVEL

You can set a viewing limit through Rating Level. Playback of the discs will stop if the disc's general rating exceeds the limit you set.

- 1 Press the **SETUP** button in stop mode.
- 2 Press the **Cursor** buttons (◀ or ▶) to select **CUSTOM**, then press the **ENTER** button.
- 3 Press the **Cursor** buttons (◀ or ▶) to select **RATINGS**, then press the **ENTER** button.
- 4 Press the **Numeric** buttons to enter your four-digit password.
  - When doing this for the first time, enter any four-digit number by pressing the **Numeric** buttons (except for 4737), then press the **ENTER** button. That number will be used as the password from the second time onward. Record your password in case you forget it.
  - If you forget the password, press **4, 7, 3, 7**. The original password will be cleared and rating levels will be set to ALL. Enter a new four-digit password, then press the **ENTER** button.
- 5 Press the **Cursor** buttons (▲ or ▼) to select **RATING LEVEL**, then press the **ENTER** button.
- 6 Press the **Cursor** buttons (▲ or ▼) to select a desired level, then press the **ENTER** button.
- 7 Press the **SETUP** button to exit and activate the new settings.

#### NOTES:

- This function may not work on some DVDs. Be sure if the **RATINGS** operates in the way you have set.
- The resume information will be cleared if you change the parental level when the resume information is on.

#### To Change the Password:

- 1 Follow the steps **1** to **4** above.
- 2 Press the **Cursor** buttons (▲ or ▼) to select **PASSWORD CHANGE**, then press the **ENTER** button.
- 3 Enter a new four-digit password, then press the **ENTER** button.
- 4 Press the **SETUP** button to exit.

### IF YOU FORGET THE PASSWORD

- 1 Press **4, 7, 3, 7** at step **4**.
  - Password will be cleared and rating level will be set to ALL.
- 2 Repeat steps **4** to **7** to re-establish the parental lock.



**CONTROL LEVELS**

- **ALL**  
Parental lock is canceled.
- **Level 8**  
DVD software of any grade (adult/general/children) can be played back.
- **Levels 7 to 2**  
Only DVD software intended for general use and children can be played back.
- **Level 1**  
Only DVD software intended for children can be played back, with those intended for adult and general use prohibited.

**Others Setting**

This function allows you to adjust Angle Icon availability, Auto Power off, brightness of the player's display panel and slide show mode.

- 1** Press the **SETUP** button in stop mode.
- 2** Press the **Cursor** buttons (◀ or ▶) to select **CUSTOM**, then press **ENTER**.
  - The custom mode will appear.
- 3** Press the **Cursor** buttons (◀ or ▶) to select **Other**, then press the **ENTER** button to confirm.
- 4** Press the **Cursor** buttons (▲ or ▼) to select an item, then press **ENTER**.

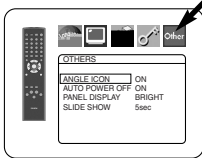

**ANGLE ICON (Default : ON)**

- Press the **ENTER** button repeatedly to turn **ON** or **OFF**.

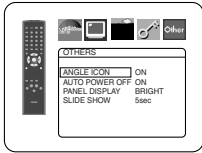

**AUTO POWER OFF (Default : ON)**

- Press the **ENTER** button repeatedly to turn **ON** or **OFF**.
- It will turn off the DVD player automatically after 30 minutes of no use.

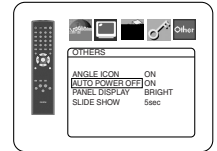

**PANEL DISPLAY (Default : BRIGHT)**

- Press the **Cursor** buttons (▲ or ▼) to select a setting (**BRIGHT**, **DIMMER** and **AUTO**), then press the **ENTER** button.
- When **AUTO** is selected, the display dims only during playback.

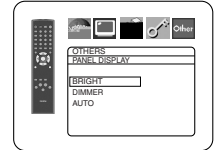

**SLIDE SHOW (Default : 5sec)**

- This adjusts the playback speed of the **JPEG SLIDE SHOW**.
- Press the **Cursor** buttons (▲ or ▼) to select between **5 sec** and **10 sec**, then press the **ENTER** button.
- 5** Press the **SETUP** button to exit.

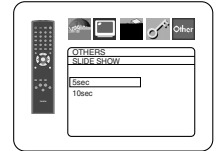

**Reset to the Default Settings (except for Ratings Control)**

This allows you to return all selections of **SETUP** (except for **RATINGS**) to their default settings.

- 1** Press the **SETUP** button in stop mode.
- 2** Press the **Cursor** buttons (◀ or ▶) to select **INITIALIZE**, then press the **ENTER** button.
- 3** Press the **Cursor** buttons (▲ or ▼) to select **YES**, then press the **ENTER** button.
- 4** Press the **SETUP** button to exit.

**NOTE:**

- If you do not wish to initialize, select **NO** at step **3**.

**Language Code List**

Language	Code	Language	Code	Language	Code	Language	Code
<b>A-B</b>							
Abkhazian	4748	French [FRE]	5264	Macedonian	5957	Siswat	6565
Afar	4747	Frisian	5271	Malagasy	5953	Slovak [SLO]	6557
Afrikaans	4752	Galician	5358	Malay	5965	Slovenian	6558
Albanian	6563	Georgian	5747	Malayalam	5958	Somali	6561
Amharic	4759	German [GER]	5051	Maltese	5966	Spanish [SPA]	5165
Arabic	4764	Greek [GRE]	5158	Maori	5955	Sundanese	6567
Armenian	5471	Greenlandic	5758	Marathi	5964	Swahili	6569
Assamese	4765	Guarani	5360	Moldavian	5961	Swedish [SWE]	6568
Aymara	4771	Gujarati	5367	Mongolian	5960		<b>T</b>
Azerbaijani	4772	Hausa	5447	Nauru	6047	Tagalog	6658
Bashkir	4847	Hebrew	5569	Nepali	6051	Tajik	6653
Basque	5167	Hindi	5455	Norwegian [NOR]	6061	Tamil	6647
Bengali; Bangla	4860	Hungarian [HUN]	5467		<b>O-R</b>	Tatar	6666
Bhutani	5072			Occitan	6149	Telugu	6651
Bihari	4854	<b>I-K</b>		Oriya	6164	Thai	6654
Bislama	4855	Icelandic [ICE]	5565	Oromo (Afan)	6159	Tibetan	4861
Breton	4864	Indonesian	5560	Panjabi	6247	Tigrinya	6655
Bulgarian [BUL]	4853	Interlingua	5547	Pashto; Pushto	6265	Tonga	6661
Burmese	5971	Interlingue	5551	Persian	5247	Tsonga	6665
Byelorussian	4851	Inupiak	5557	Polish [POL]	6258	Turkish [TUR]	6664
		Irish [IRI]	5347	Portuguese [POR]	6266	Turkmen	6657
		Italian [ITA]	5566	Quechua	6367	Twi	6669
		Japanese [JPN]	5647	Rhaeto-Romance	6459		<b>U-Z</b>
Cambodian	5759	Javanese	5669	Romanian [RUM]	6461	Ukrainian	6757
Catalan	4947	Kannada	5760	Russian [RUS]	6467	Urdu	6764
Chinese [CHI]	7254	Kashmiri	5765		<b>S</b>	Uzbek	6772
Corsican	4961	Kazakh	5757	Samoan	6559	Vietnamese	6855
Croatian	5464	Kinyarwanda	6469	Sangho	6553	Volapuk	6861
Czech [CZE]	4965	Kirghiz	5771	Sanskrit	6547	Welsh	4971
Danish [DAN]	5047	Kirundi	6460	Scots Gaelic	5350	Wolof	6961
Dutch [DUT]	6058	Korean [KOR]	5761	Serbian	6564	Xhosa	7054
English [ENG]	5160	Kurdish	5767	Serbo-Croatian	6554	Yiddish	5655
Esperanto	5161			Sesotho	6566	Yoruba	7161
Estonian	5166	<b>L-N</b>		Setswana	6660	Zulu	7267
		Laothian	5861	Shona	6560		
		Latin	5847	Sindhi	6550		
Faroese	5261	Latvian; Lettish	5868	Singhalese	6555		
Fiji	5256	Lingala	5860				
Finnish [FIN]	5255	Lithuanian	5866				

If you choose a language that has a three-letter language code (written in bracket), the code will be displayed every time you change the Audio or Subtitle Language setting on page 21. If you choose any other languages, '---' will be displayed instead.

## TROUBLESHOOTING GUIDE

If the DVD player does not perform properly when operated as instructed in this Operating Instruction, check the player, consulting the following checklist.

Problem	Solution	Page
<b>No power</b>	<ul style="list-style-type: none"> <li>– Check if the AC power cord is properly connected.</li> <li>– Unplug the AC power cord once, and wait for 5-10 seconds and then plug it in again.</li> </ul>	— —
<b>No sound or picture</b>	<ul style="list-style-type: none"> <li>– Check if the TV is turned on.</li> <li>– Check the video connection and HDMI connection.</li> <li>– Check the VIDEO/AUDIO cable connections.</li> <li>– Check if the PROGRESSIVE mode is set correctly.</li> </ul>	— 13-14 12-13 11, 23
<b>Distorted picture</b>	<ul style="list-style-type: none"> <li>– Sometimes a small amount of picture distortion may appear. This is not a malfunction.</li> <li>– Connect the player directly to the TV.</li> <li>– Check if the PROGRESSIVE mode is set correctly.</li> <li>– Check the TV TYPE (MULTI, NTSC or PAL).</li> </ul>	— 13 11, 23 15, 23
<b>Completely distorted picture or black/white picture with DVD</b>	<ul style="list-style-type: none"> <li>– Connect the DVD player directly to the TV.</li> <li>– Make sure the disc is compatible with the DVD player.</li> </ul>	13 6
<b>No sound or distorted sound</b>	<ul style="list-style-type: none"> <li>– Adjust the volume.</li> <li>– Check that the speakers are connected correctly.</li> <li>– The HDMI sound is not output when AUDIO MODE is set to ANALOG.</li> </ul>	— 12 24
<b>No audio at digital output</b>	<ul style="list-style-type: none"> <li>– Check the digital connections.</li> <li>– Check the audio settings.</li> </ul>	12, 14 24
<b>No DTS sound output</b>	<ul style="list-style-type: none"> <li>– Use a DIGITAL OUT jack when outputting the DTS sound.</li> </ul>	12, 24
<b>No image from HDMI connection</b>	<ul style="list-style-type: none"> <li>– Check the HDMI connection. (Check the status of the HDMI related indications.)</li> <li>– Check whether the connected monitor equipment or other equipment supports HDCP. (This player will not output a video signal unless the other equipment supports HDCP.)</li> <li>– Check the setting of HDMI.</li> <li>– Check whether the output format of this player (HDMI FORMAT) matches the supported input format of other connected equipment.</li> </ul>	14, 15 14 14, 24 14
<b>Picture freezes momentarily during playback</b>	<ul style="list-style-type: none"> <li>– Check the disc for fingerprints/scratches and clean with a soft cloth wiping from center to edge.</li> <li>– Clean the disc.</li> </ul>	27 27
<b>Disc cannot be played</b>	<ul style="list-style-type: none"> <li>– Clean the disc.</li> <li>– Ensure the disc label is facing up.</li> <li>– Check if the disc is defective by trying another disc.</li> <li>– Cancel Ratings control or change the control level.</li> <li>– Insert a correct disc that plays on this player.</li> </ul>	27 15 — 24-25 6
<b>No return to start-up screen when disc is removed</b>	<ul style="list-style-type: none"> <li>– Reset the player by turning it off, then on again.</li> </ul>	—
<b>The player does not respond to the remote control</b>	<ul style="list-style-type: none"> <li>– Aim the remote control directly at the sensor on the front of the player.</li> <li>– Reduce the distance to the player.</li> <li>– Replace the batteries in the remote control.</li> <li>– Re-insert the batteries with their polarities (+/- signs) as indicated.</li> </ul>	8 — 10 10
<b>Buttons do not work or player stops responding</b>	<ul style="list-style-type: none"> <li>– To completely reset the player, unplug the AC cord from the AC outlet for 5-10 seconds.</li> </ul>	—
<b>Player does not respond to some operating commands during playback</b>	<ul style="list-style-type: none"> <li>– Operations may not be permitted by the disc. Refer to the instructions of the disc.</li> </ul>	6
<b>DVD player cannot read CDs/DVDs</b>	<ul style="list-style-type: none"> <li>– Use a commonly available CD/DVD cleaner to clean the lens before sending the DVD player for repair.</li> </ul>	27
<b>Angle does not switch</b>	<ul style="list-style-type: none"> <li>– The angle cannot be switched for DVDs which do not contain multiple angles. In some cases multiple angles are only recorded for specific scenes.</li> </ul>	22
<b>Playback does not start when the title is selected</b>	<ul style="list-style-type: none"> <li>– Check the "RATINGS" setting.</li> </ul>	24-25
<b>The password for rating level has been forgotten</b>	<ul style="list-style-type: none"> <li>– Enter the default password "4737", then your forgotten password will be cleared.</li> </ul>	24-25

### NOTES:

- Some functions are not available in specific modes, but this is not a malfunction. Read the description in this Operating Instruction for details on correct operations.
- Playback from a desired track and random playback are not available during program playback.
- Some functions are prohibited on some discs.

## SPECIFICATIONS

### SIGNAL SYSTEM

NTSC/PAL color

### APPLICABLE DISCS

- (1) DVD-Video Discs
  - 1-layer 12cm single-sided discs, 2-layer 12cm single-sided discs, 2-layer 12cm double-sided discs (1 layer per side)
  - 1-layer 8cm single-sided discs, 2-layer 8cm single-sided discs, 2-layer 8cm double-sided discs (1 layer per side)
- (2) DVD-R/DVD-RW
- (3) Compact discs (Audio CD)
  - 12cm discs, 8cm discs
- (4) CD-R/CD-RW

### S-VIDEO OUTPUT

Y output level: 1Vp-p (75Ω/ohms)  
 C output level: 0.286Vp-p  
 Output connectors: S connectors, 1 set

### VIDEO OUTPUT

Output level: 1Vp-p (75Ω/ohms)  
 Output connector: Pin jacks, 1 set

### COMPONENT OUTPUT

Y output level: 1Vp-p (75Ω/ohms)  
 Pb/Cb output level: 0.648Vp-p (75Ω/ohms)  
 Pr/Cr output level: 0.648Vp-p (75Ω/ohms)  
 Output connector: Pin jacks, 1 set

### HDMI OUTPUT

HDMI jack, 1 set

### AUDIO OUTPUT

Output level: 2Vrms  
 2 channel (L, R) output connector: Pin jack, 1 set

### AUDIO OUTPUT PROPERTIES

- (1) Frequency response
  - 1 DVDs (linear PCM) : 4Hz to 22kHz (48kHz sampling)
  - : 4Hz to 44kHz (96kHz sampling)
  - 2 CDs : 4Hz to 20kHz
- (2) S/N ratio : 115dB
- (3) Total harmonic distortion : 1kHz CD: 0.004%
- (4) Dynamic range : DVD: 100dB  
                               CD: 98dB

### DIGITAL AUDIO OUTPUT

Optical digital output: Optical connector, 1 set  
 Coaxial digital output: Pin jack, 1 set

### POWER SUPPLY

AC 120V, 60Hz

### POWER CONSUMPTION

7W (Standby: 0.3W)

### MAXIMUM EXTERNAL DIMENSIONS

W: 17-3/32" (435mm)  
 H: 2-61/64" (75mm)  
 D: 12-13/64" (310mm)  
 (including protruding parts)

### MASS

5.06 lbs (2.3 kg)

### REMOTE CONTROL UNIT

RC-1018  
 Infrared pulse type  
 Supply: DC 3V, 2 R6P/AA batteries

## MAINTENANCE

### Cleaning the Cabinet

- Use a soft cloth slightly moistened with a mild detergent solution. Do not use a solution containing alcohol, spirits, ammonia or abrasives.

### Cleaning Discs

- When a disc becomes dirty, clean it with a cleaning cloth. Wipe the disc from the center out. Do not wipe in a circular motion.
- Do not use solvents such as benzene, thinner, commercially available cleaners, detergent, abrasive cleaning agents or antistatic spray intended for analog records.

### Cleaning the disc lens

- If the player still does not perform properly when it is operated while referring to the relevant sections and to "TROUBLESHOOTING GUIDE" in this Operating Instruction, the laser optical pickup unit may be dirty. Consult your dealer or an Authorized Service Center for inspection and cleaning of the laser optical pickup unit.

### Disc Handling

- Use discs which have the following logos on them.
- Handle the discs so that fingerprints and dust do not adhere to the surfaces of the discs.
- Always store the disc in its protective case when it is not used.
- Note that discs with special shapes (heart-shaped discs, octagonal discs, etc.) cannot be played on this product. Do not attempt to play such discs, as they may damage the player.



MP3



Printed in China  
00D 511 4655 003

**DENON**  
TOKYO, JAPAN  
[www.denon.com](http://www.denon.com)

Denon Brand Company, D&M Holdings Inc.  
1VMN23654  
E6E80UD \*\*\*\*\*